

QTi DALI 2X35/49/80 DIM

QUICKTRONIC INTELLIGENT DALI DIM T5 | ECG dimmable DALI for FL 16 mm



Areas of application

- Suitable for use in emergency lighting systems as per EN 50172/DIN VDE 0108-100
- Installation in emergency lighting systems according to IEC 61347-2-3, appendix J
- Industry
- Open-plan offices, corridors and storage rooms
- Public buildings
- Sports halls and factories
- Strip lighting
- Shop lighting
- Suitable for luminaires of protection class I

Product benefits

- System+ Guarantee available
- Easy integration in luminaire thanks to same dimensions like DALI GI ECG
- TouchDIM function for easy and inexpensive dimming of several ECGs
- Same luminous flux with direct and alternating current
- Dimming of amalgam lamps without flickering or reduced lifespan
- Automatic restart after lamp replacement
- No new approvals required

DALI product features

- Control via the DALI interface
- Compliance with the DALI standard to IEC 60929 and IEC 62386
- Control input protected against overvoltage and polarity reversal (OSRAM ECG)

Touch DIM and Touch DIM Sensor function

- Manual dimming without controller and with standard switches
- Including memory function (double click) and soft start

Product features

-

Product datasheet

- Corridor function for direct connection of ECG to common motion sensor
- Corridor function with pre-programmed light program
- Touch DIM function for free parameterization of light value and turn on time
- Fit for SMART GRID for feedback of consumed mains power and lamp operating hours
- Fit for Emergency function for automatic detection of emergency lighting by ECG
- Very low standby power consumption: < 0.2 W (A1 BAT)
- Lifetime: > 100,000 h (for T = 65 °C at T_c)
- Very high number of switching cycles: up to 300,000
- Dimming range: 1...100 % (3...100 % with compact fluorescent lamp)
- POWER2LAMP function for optimal matching of ECG power to lamp during lamp lifetime
- Line frequency: 0 Hz, 50...60 Hz, rectified AC

Product datasheet

Technical data

Electrical data

Input voltage AC	198...264 V
Nominal voltage	220...240 V
Mains frequency	50...60 Hz
Input voltage DC	154...276 V
Operating frequency	44...120 kHz
Max. ECG no. on circuit breaker 10 A (B)	5 ¹⁾
Max. ECG no. on circuit breaker 16 A (B)	9 ¹⁾
Inrush current	60 A

¹⁾ Type B

Light technical data

Starting time	0.6 s ¹⁾
---------------	---------------------

¹⁾ Optimized preheat start

Dimensions & weight

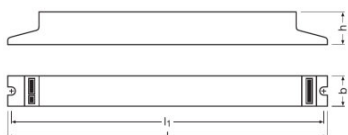

Length	423.0 mm
Width	30.0 mm
Height	21.0 mm
Mounting hole spacing, length	415.0 mm
Product weight	370.00 g
Cable cross-section, output side	0.5...1.5 / 0.5...1.0 mm ² ¹⁾
Cable cross-section, input side	0.5...1.5 / 0.5...1.0 mm ² ¹⁾

¹⁾ Solid leads / Flexible

Temperatures & operating conditions

Ambient temperature range	+10...+50 °C
---------------------------	--------------

Product datasheet

Permitted rel. humidity during operation	5...85 %
---	----------

Lifespan

ECG lifetime	100000 h ¹⁾
---------------------	------------------------

¹⁾ At $T_{case} = 65^{\circ}C$ at T_c point / 10% failure rate

Expected Lifetime

Product name	Lamp group				
QTi DALI 2X35/49/80 DIM	HE 35 W	ECG ambient temperature [ta]	40	50	60
		Temperature at tc-point [°C]	50	60	70
		Lifetime [h]	100000	100000	100000
	HO 45 W ES	ECG ambient temperature [ta]	40	50	60
		Temperature at tc-point [°C]	50	60	70
		Lifetime [h]	100000	100000	100000
	HO 49 W	ECG ambient temperature [ta]	40	50	60
		Temperature at tc-point [°C]	50	60	70
		Lifetime [h]	100000	100000	100000
	HO 73 W ES	ECG ambient temperature [ta]	40	50	60
		Temperature at tc-point [°C]	60	70	75
		Lifetime [h]	100000	100000	80000
	HO 80 W	ECG ambient temperature [ta]	40	50	60
		Temperature at tc-point [°C]	60	70	75
		Lifetime [h]	100000	100000	80000
	HO 80 W XT	ECG ambient temperature [ta]	40	50	60
		Temperature at tc-point [°C]	60	70	75
		Lifetime [h]	100000	100000	80000

Capabilities

Dimming interface	DALI / Touch DIM / Touch DIM Sensor
Dimming range	1...100 % ¹⁾
Dimmable	Yes
Overheating protection	Power reduction and switch off at $T > 75^{\circ}C$ at the tc point
Suitable for fixtures with prot. class	I
End of lamp life safety shutdown	EOL T.2

¹⁾ Luminous flux

Certificates & standards

Approval marks – approval	VDE / VDE-EMC / ENEC 10 / EL / GOST / RCM / CCC
Standards	Acc. to EN 61347-2-3/Acc. to EN 60929/Acc. to EN 55015:2006 + A1:2007/Acc. to EN 61000-3-2/Acc. to EN 61547
EEL – Energy Label	A1 BAT
Protection class	I
Type of protection	IP20

Wiring Diagram

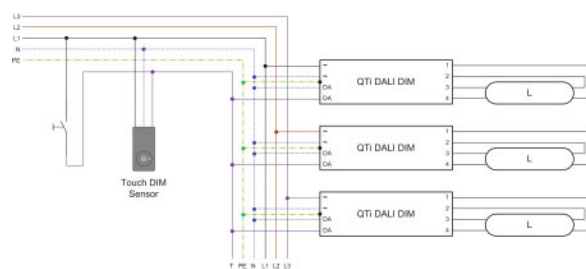
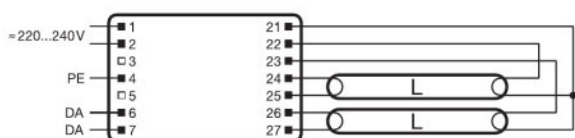

Wiring diagram

Wiring diagram

Product datasheet

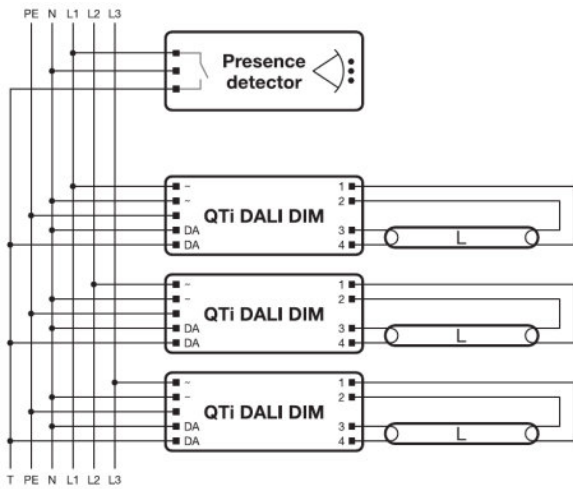



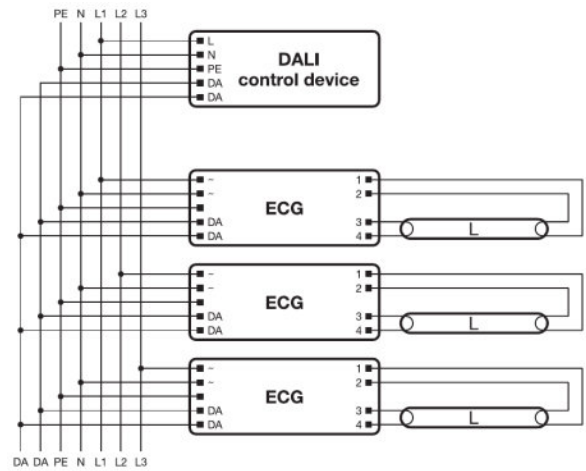







Wiring diagram











Wiring diagram

Download Data

File	
	Addon Technical Information Frequent switching Quicktronic
	Addon Technical Information ECG lifetime - QUICKTRONIC (DALI) DIM
	Brochures Bochure DALI partner
	Brochures Applications and luminaire solutions
	Certificates INOTEC
	Certificates ENECVDE-Marks approval
	Certificates Manufacturer's declaration Burning-in of fluorescent lamps
	Certificates Manufacturer's declaration Low stand-by
	Certificates Manufacturer's declaration EN 55015:2006+A1:2007 (300 MHz)
	Certificates Manufacturer's declaration LampECG combinations: Frequent switching
	Certificates VDE-EMC-CERTIFICATE QTİ DALI DIM

Product datasheet

	Certificates 592319_EAC certificate for Quicktronics QT
	Declarations of conformity Declaration of conformity
	Installation/Operation notice Technical guide - ECGs for T5-lamps
	Installation/Operation notice Technical application guide QUICKTRONIC Intelligent DALI DIM (GB)
	Operating instructions EAC QT _i T5 DALI DIM
	CAD data 3-dim 423x30x21 1881282
	CAD data 3-dim 423x30x21 1881282
	CAD data 3-dim 423x30x21 1881282
	CAD data PDF 423x30x21 1881282

Logistical Data

Product code	Product description	Packaging unit (Pieces/Unit)	Dimensions (length x width x height)	Volume	Gross weight
4050300870441	QT _i DALI 2X35/49/80 DIM	Shipping carton box 20	435 mm x 96 mm x 170 mm	7.10 dm ³	7642.00 g

The mentioned product code describes the smallest quantity unit which can be ordered. One shipping unit can contain one or more single products. When placing an order, for the quantity please enter single or multiples of a shipping unit.

References / Links

For more information on the system guarantee and the terms and conditions of the guarantee visit

▶ www.osram.com/system-guarantee

Disclaimer

Subject to change without notice. Errors and omission excepted. Always make sure to use the most recent release.

QTi DALI 2X35/49/80 DIM

QUICKTRONIC INTELLIGENT DALI DIM T5 | ECG dimmable DALI for FL 16 mm

Product name	Lamp group	Nominal current	Nominal wattage + Power loss	Luminous flux at 35 °C	Number of lighting outlets
QTi DALI 2X35/49/80 DIM	DULUX L 80 W	0.74 A	165.00 W	6000 lm	2
	HE 35 W	0.34 A	74.00 W	3300 lm	2
	HE 35 W XT	0.34 A	74.00 W	3300 lm	2
	HO 45 W ES	0.45 A	101.00 W	4600 lm	2
	HO 49 W	0.46 A	101.00 W	4300 lm	2
	HO 73 W ES	0.72 A	165.00 W	6400 lm	2
	HO 80 W	0.74 A	165.00 W	6150 lm	2
	HO 80 W XT	0.74 A	165.00 W	6150 lm	2