

VATES 18 SSLED

⊖ indoor/ downlights

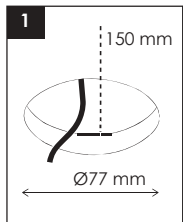

Installation
Cut the ceiling

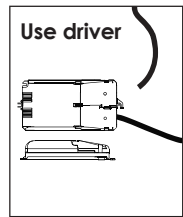
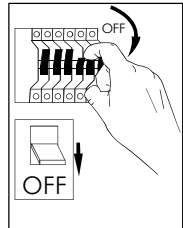

Tool accessories

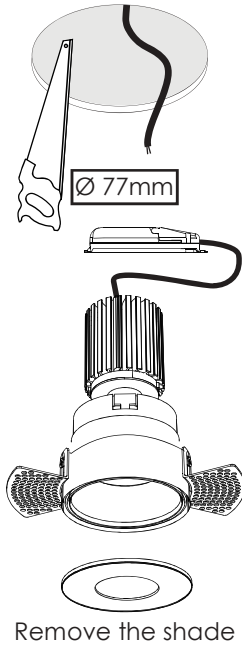
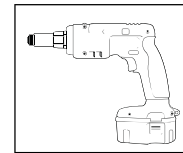

2 Remove the inner shade and source.

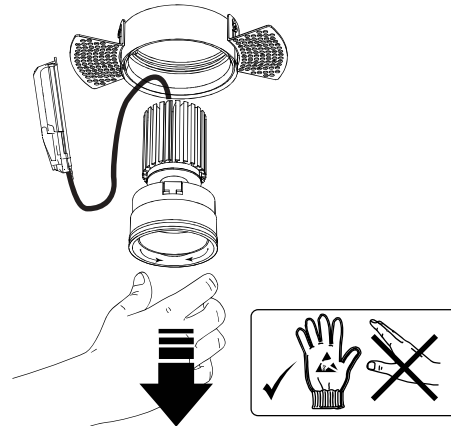

3 Adjust the false ceiling brackets and then fit the fixture in the ceiling.

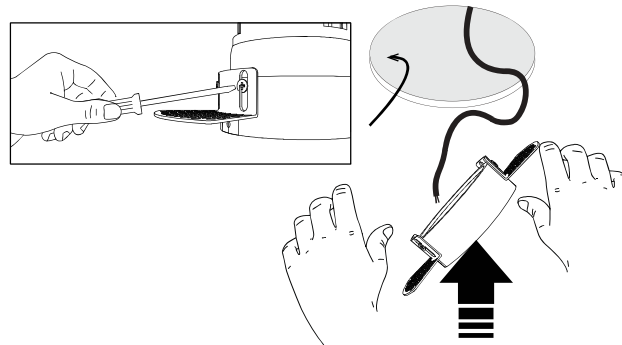

4 Screw the fixture on ceiling
Hold the luminaire while using the drill.

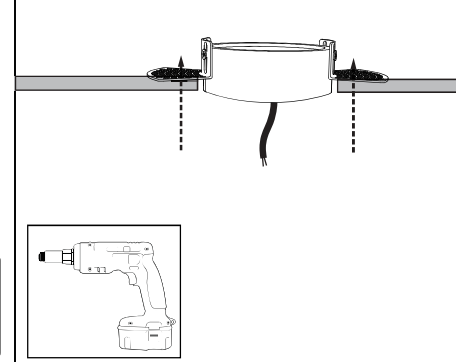

5 Grouting. Paint the false ceiling

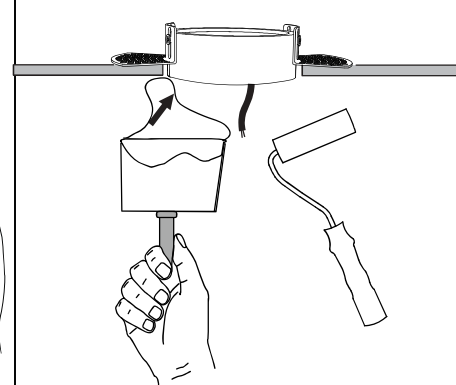

6 Make wiring connection

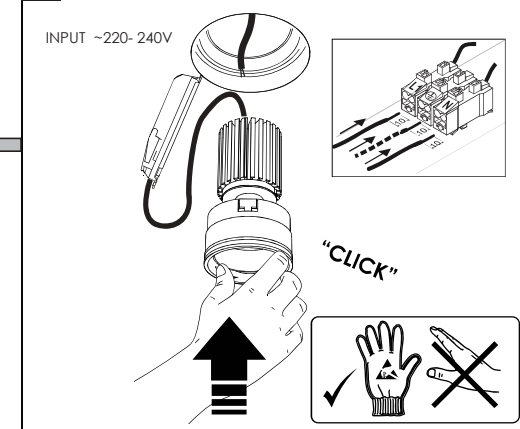

7 Fit the shade

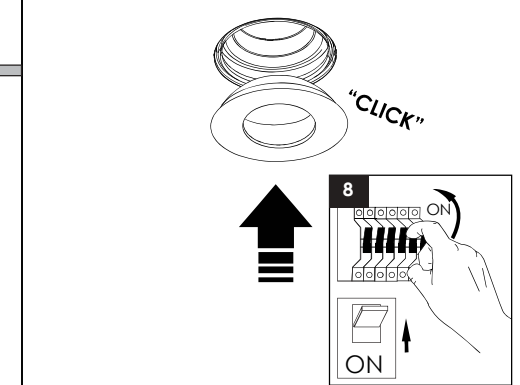

USER INSTRUCTIONS

- The installation of the unit must be done by a qualified electrician.
- The unit must be earthed in case an earth connecting point exists.
- Ensure that the mains is switched off during servicing.
- Do not use bulb(s) bigger than the indicated on units name-plate or packaging.
- Ensure that after the installation, the unit is properly fixed and the cable clamps (if exist) are well tightened.
- Manufacturer will not accept liability for injury or damage resulting from incorrect use or installation
- The unit is not intended to operate in loop connection.
- Wall plugs and terminals are not included.
- LED modules are replaced only by the manufacturer.

CAUTION

Wear anti-static gloves before you touch LED systems

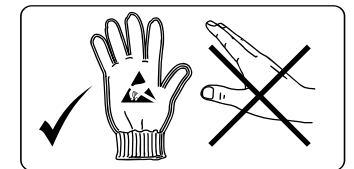

Factory

5 Kefalovrisou Str., Monomati, Acharnai, P.O. Box 13677, Athens, Greece | Tel: (+30) 210 6208 230
E-mail: info@bright.gr | www.bright.gr